

© 2009 Terezinha Nunes

Maths session 7



BK 7

Child's name: \_\_\_\_\_

Date: \_\_\_\_\_

School: \_\_\_\_\_

© 2009 Terezinha Nunes

Maths session 7

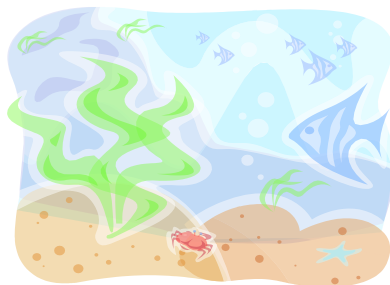

BK 7

Child's name: \_\_\_\_\_

Date: \_\_\_\_\_

School: \_\_\_\_\_

7A.	
-----	--

7B.	
-----	--

7C.	
-----	--

7D.	
-----	--

7E.	
-----	--

7F.	
-----	--

7A.	
-----	--

7B.	
-----	--

7C.	
-----	--

7D.	
-----	--

7E.	
-----	--

7F.	
-----	--

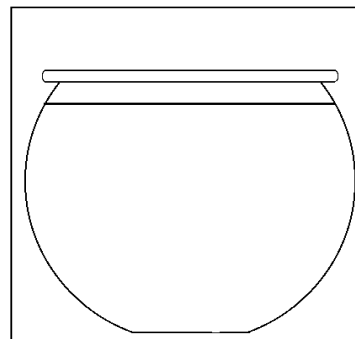
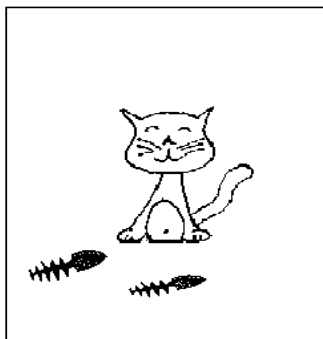
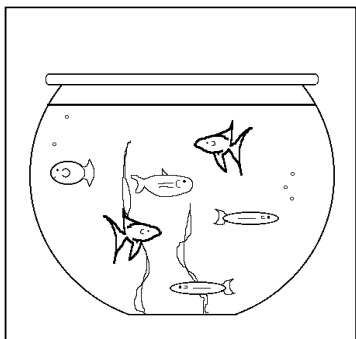

6

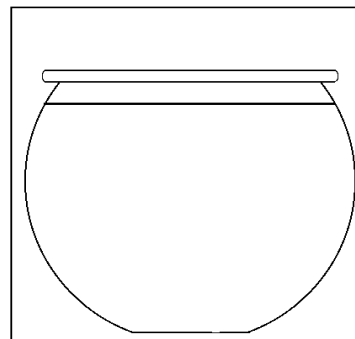
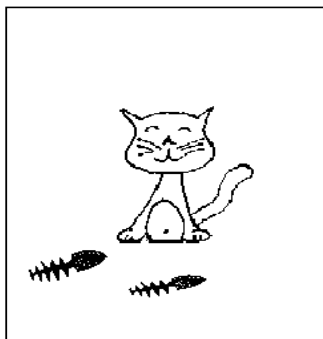
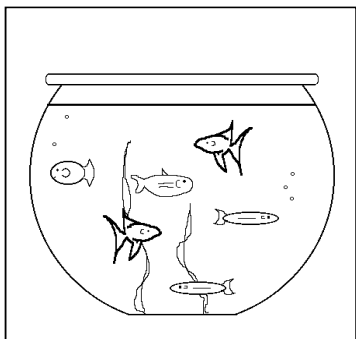
 $-2$ 

6

 $-2$



7



-



2



7



-



2

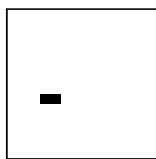
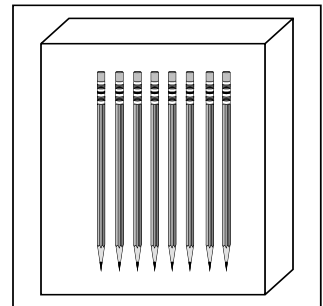
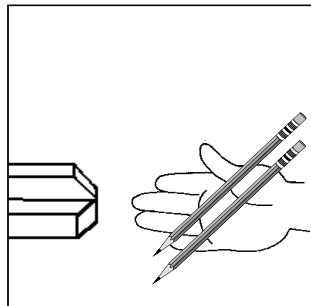
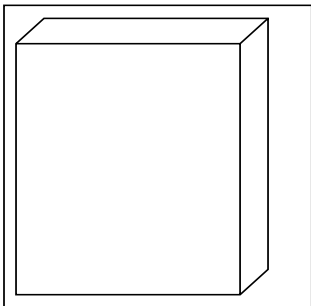
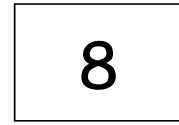
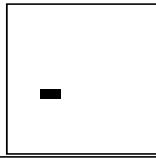
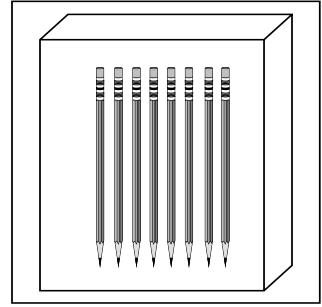
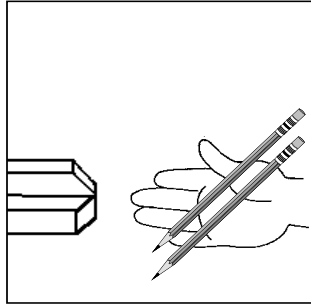
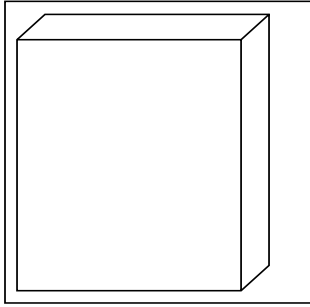

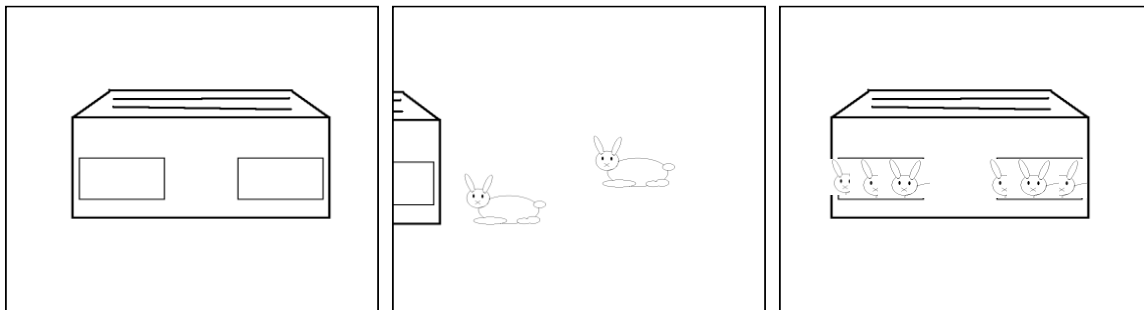

$$\square + \square = 6$$

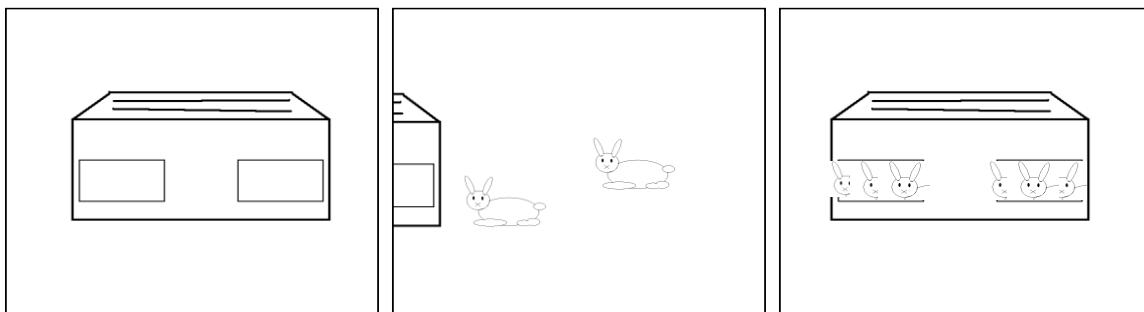

$$\square + \square = 6$$

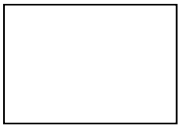
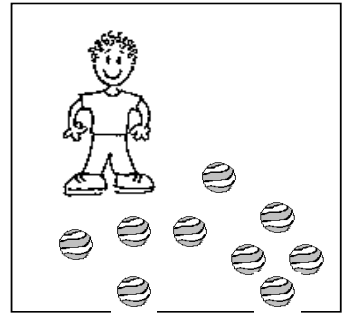
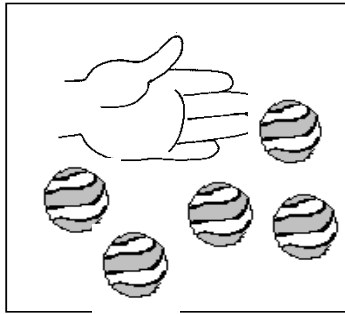
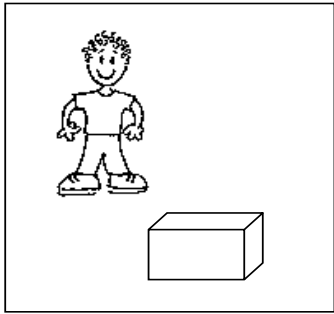

+

9

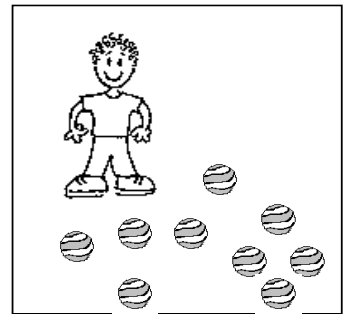
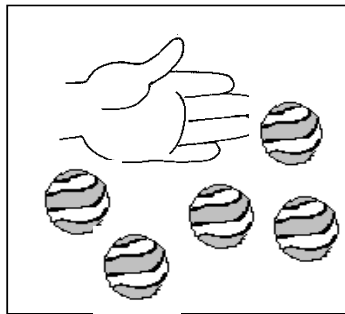
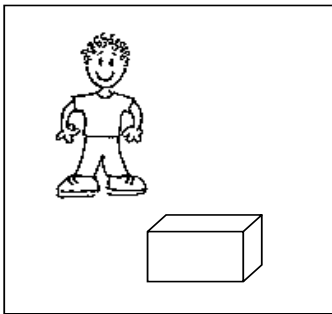

+

9

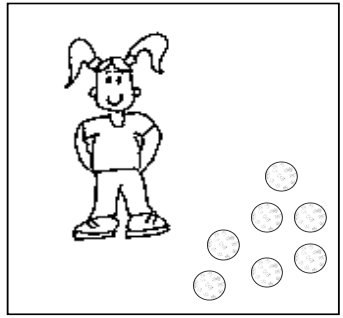
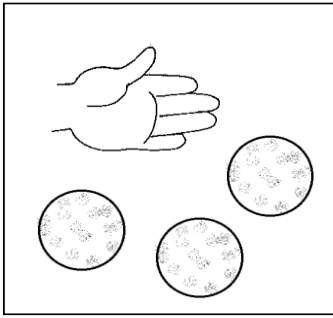
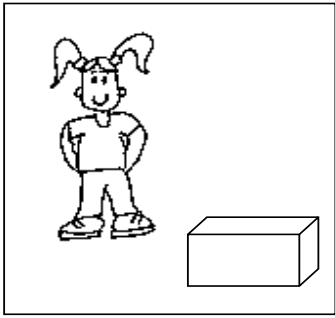

$$- 3$$

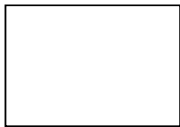
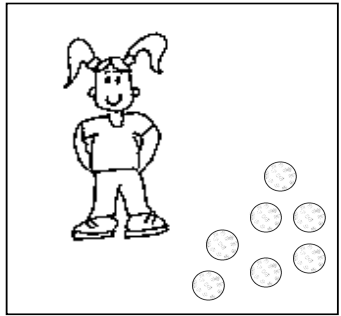
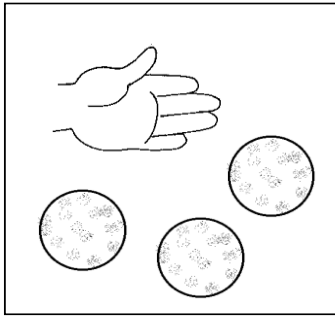
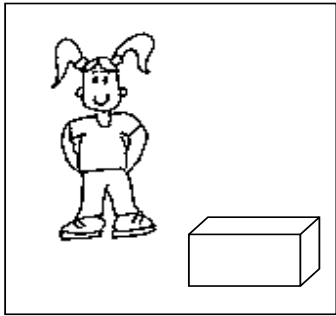
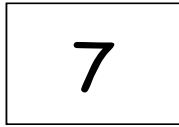

$$- 3$$





7M



Your first answer

Biscuits altogether

7N



Your first answer

Biscuits altogether

7O



Your first answer

Rabbits each

7M



Your first answer

Biscuits altogether

7N

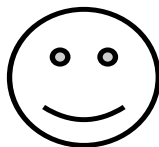

Your first answer

Biscuits altogether

7O

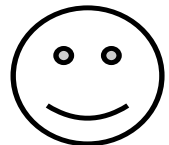

Your first answer

Rabbits each

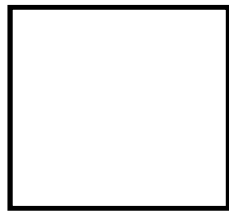

**Tadpoles**

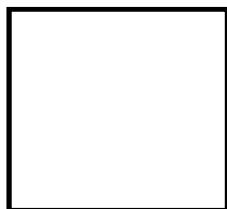

**Tadpoles**

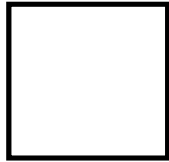
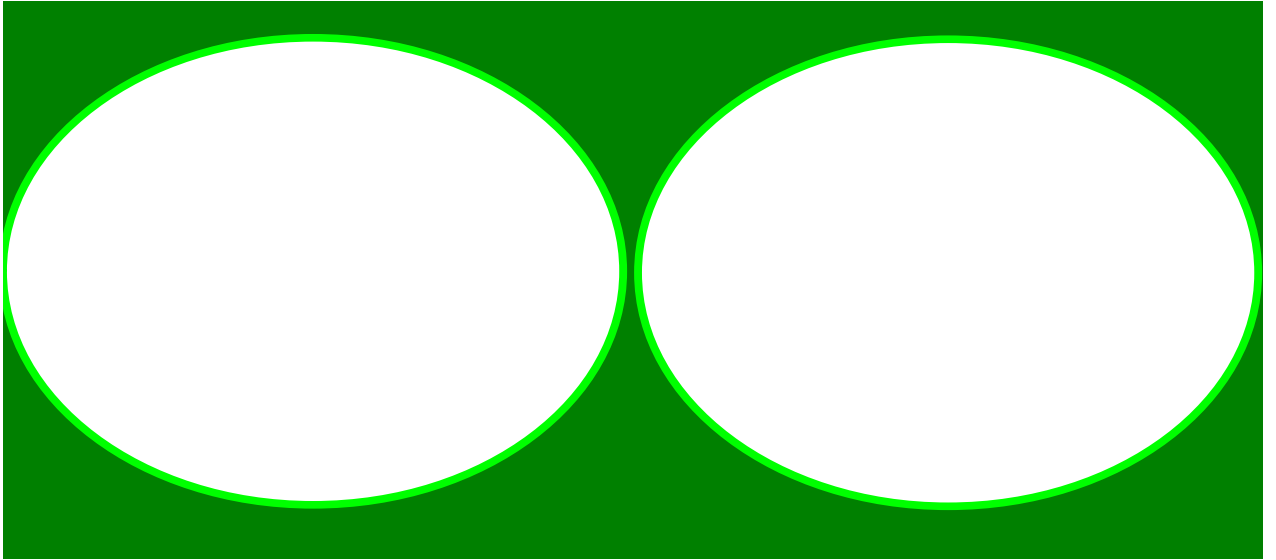

**Walnuts**

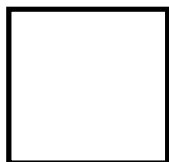
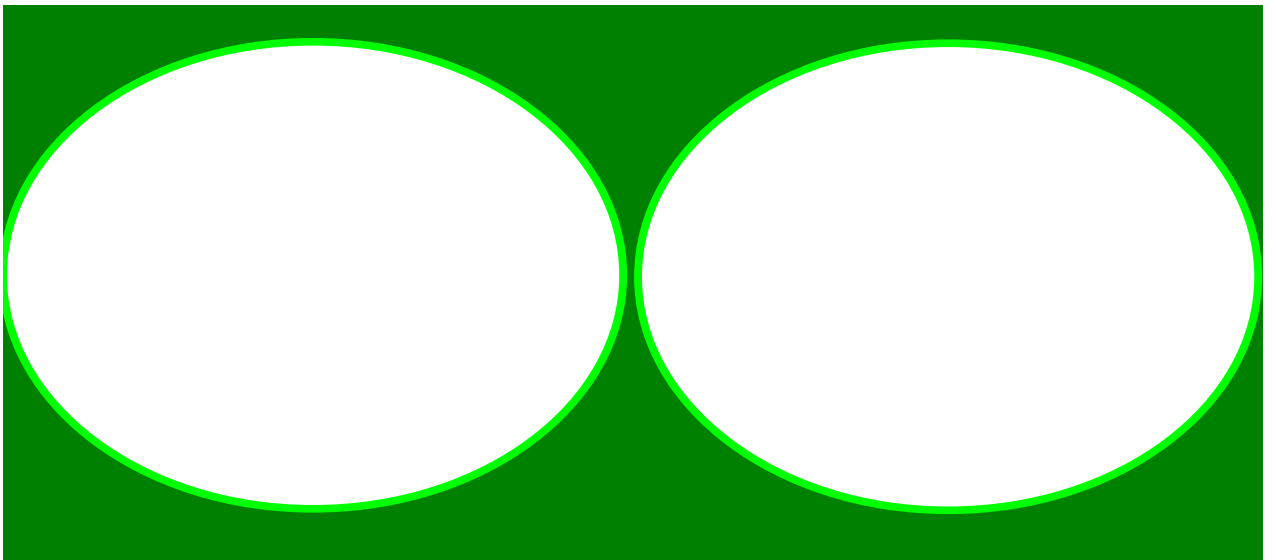

**Walnuts**



7R



Cookies

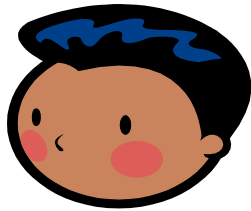

7R

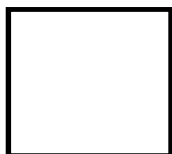

Cookies